

SM Microscope ON/OFF Procedures (Quick Reference)

Sign In

1. Sign in for "Microscope" from the laptop computer.
2. Select laser option.

Lasers

1. Turn on power supply for detector(s) as needed.
2. Take care not to expose to room lights.
3. Turn off power supply when done.

APD Detectors

PicoQuant PicoHarp

Additional Microscope Components

Argon

1. Turn power switch on.
2. Turn interlock key to right position.
3. Select wavelength using micrometer.
4. Reverse to turn off.

Fianium

1. Press green oscillator button on laser power supply.
2. Wait 10 minutes.
3. Turn key switch to "I" position.
4. Turn amplitude knob clockwise to maximum limit.
5. Click "Fianium AOTF controller" icon on PC desktop to control wavelength and power. Load "default visible" calibration settings located on desktop.
6. Reverse steps 1-4 to turn off. (Do not need to wait 10 min, and make sure that the power knob is set back to minimum).

1. Turn on power supply to PHR 800 routers using button on back of unit.
2. Turn on power supply to PicoHarp using button on back of unit.
3. Turn on power supply (BK Precision) to amplifier.
4. Click "PicoHarp" icon on desk to open operating software.
5. Reverse to shut down.

1. Turn on external power supply to lamp (if needed). Shutter and attenuation knob located on left side of microscope base.
2. Turn on power supply to Mad City Labs nanostage (if needed).
3. To use ALV correlator click ALV-Software icon on desktop.

System Shutdown

- Turn off microscope hardware components as described above.
- Close programs.
- Logoff laptop computer.

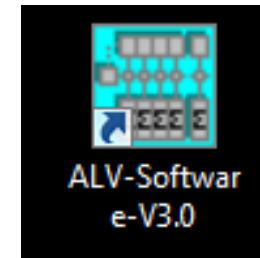
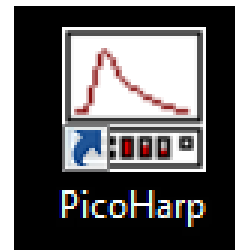

Notes for Argon Laser

- Adjust wavelength using upper right micrometer on back of laser head.
- Reference chart to associate micrometer setting with wavelength.
- Fine tune using lower left micrometer.
- Leave power supply on for 5 min after turning off interlock switch before turning power off.

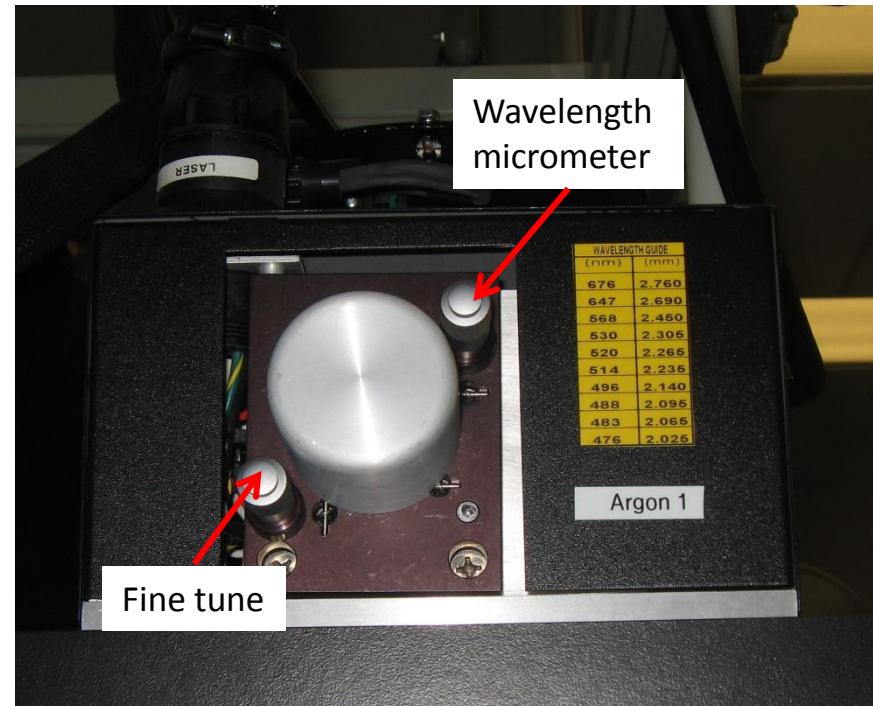
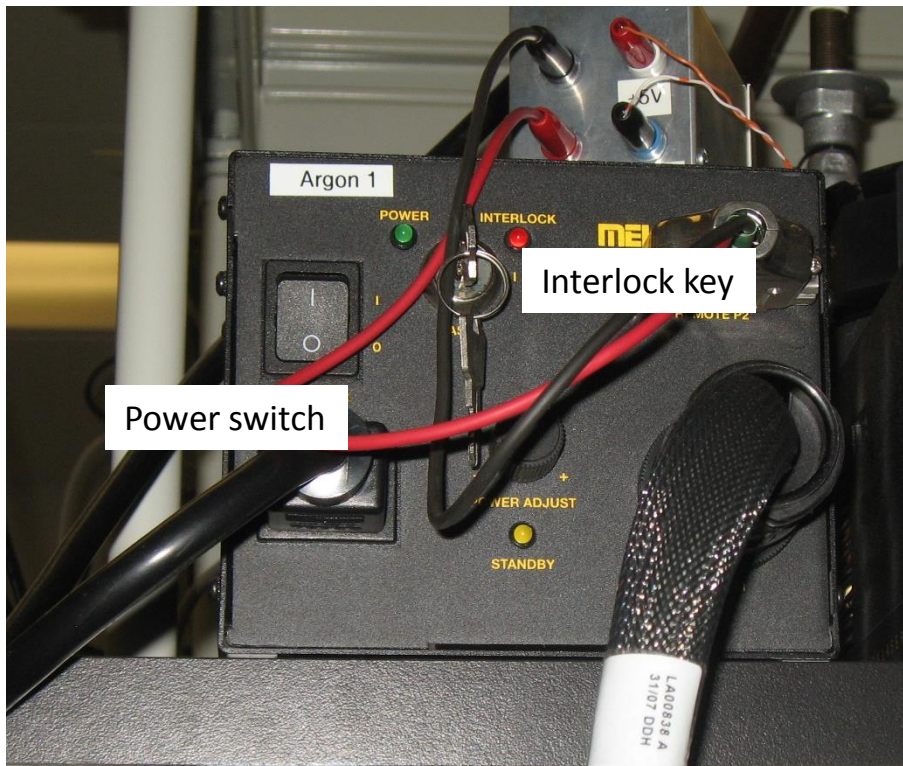

Fianium Laser

- Output of fiber collimator has a beam diameter of 8.5 mm.
- When running laser set attenuation knob to max value. Adjust final output power using “Fianium AOTF controller” program.

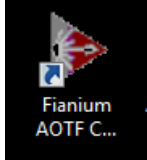

Icon to launch AOTF control program.

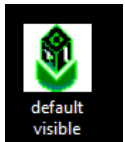

Click “Settings” → “Load” to get calibration settings value, “default visible” located on the desktop.

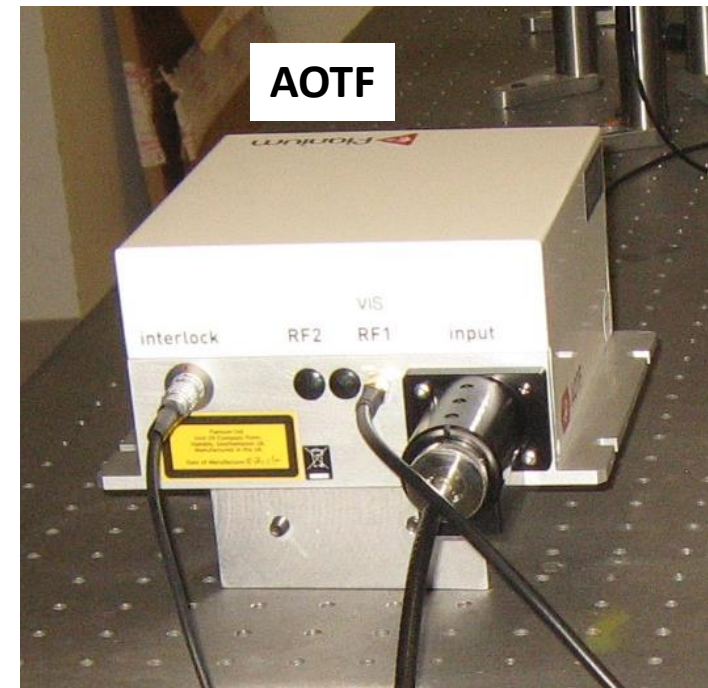
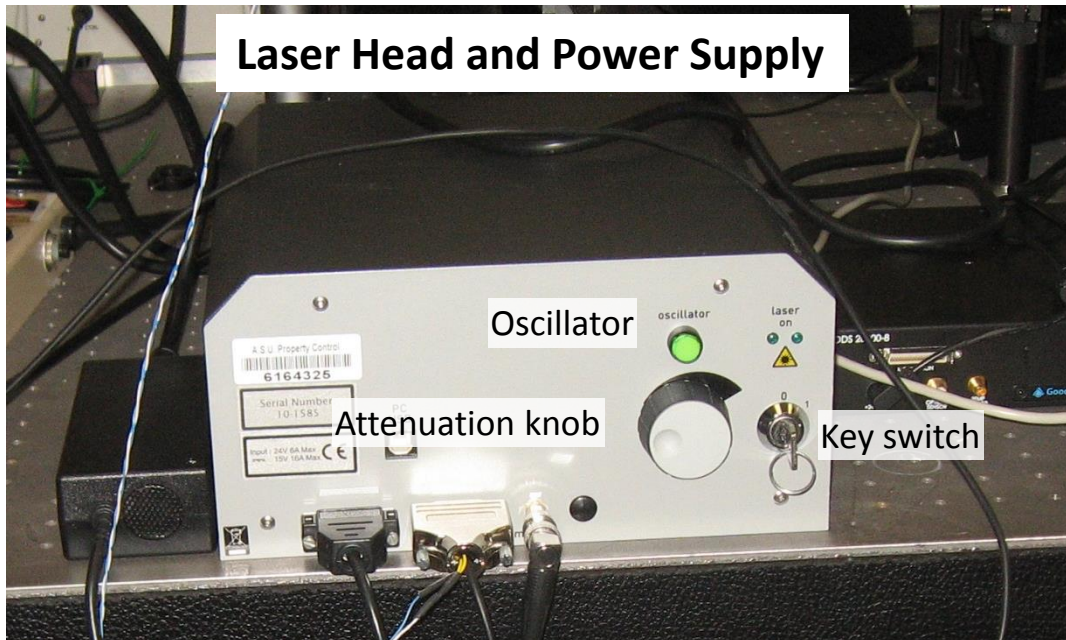

Optics Setup for Laser Input

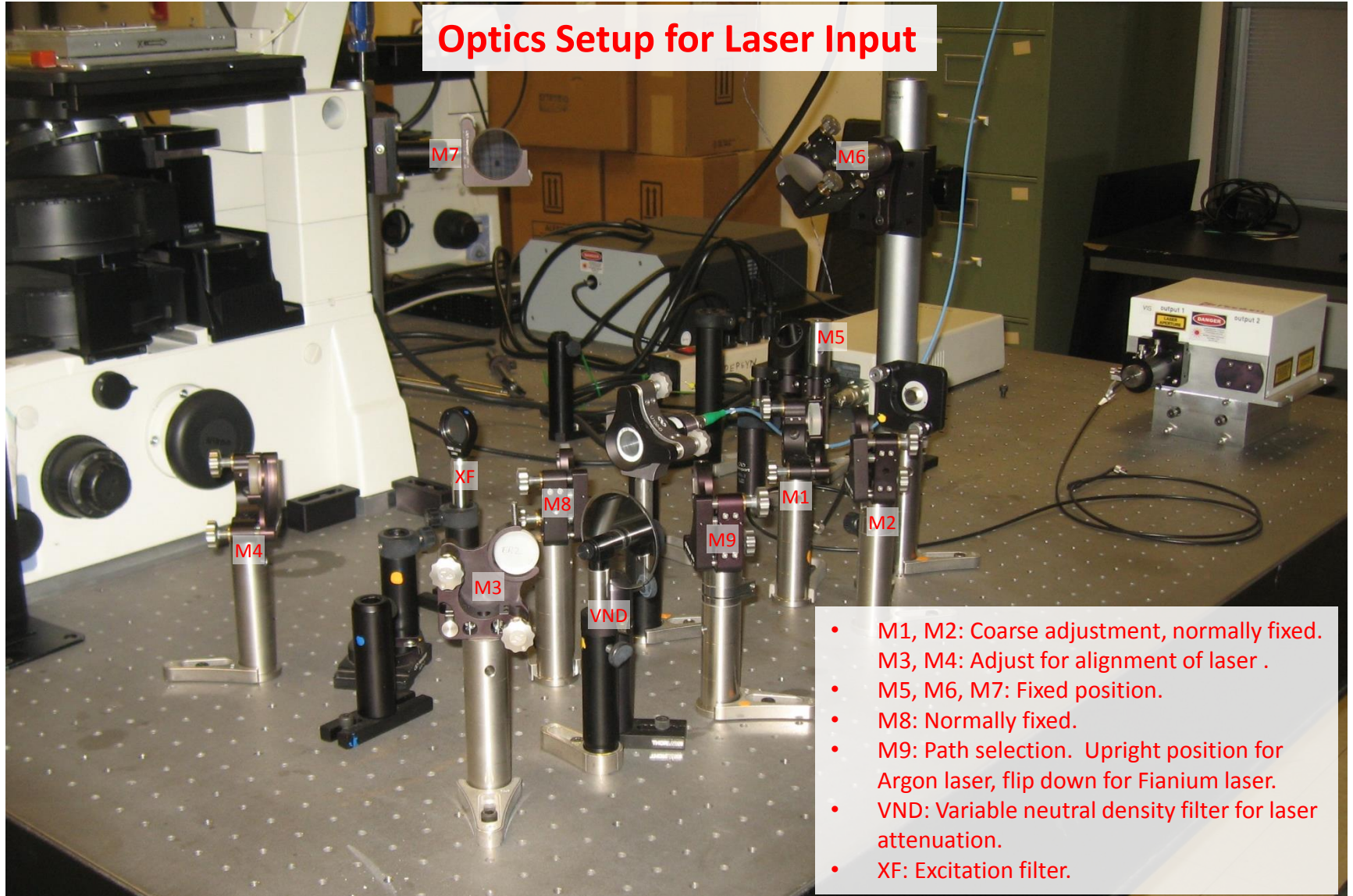

- M1, M2: Coarse adjustment, normally fixed.
- M3, M4: Adjust for alignment of laser .
- M5, M6, M7: Fixed position.
- M8: Normally fixed.
- M9: Path selection. Upright position for Argon laser, flip down for Fianium laser.
- VND: Variable neutral density filter for laser attenuation.
- XF: Excitation filter.

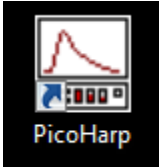
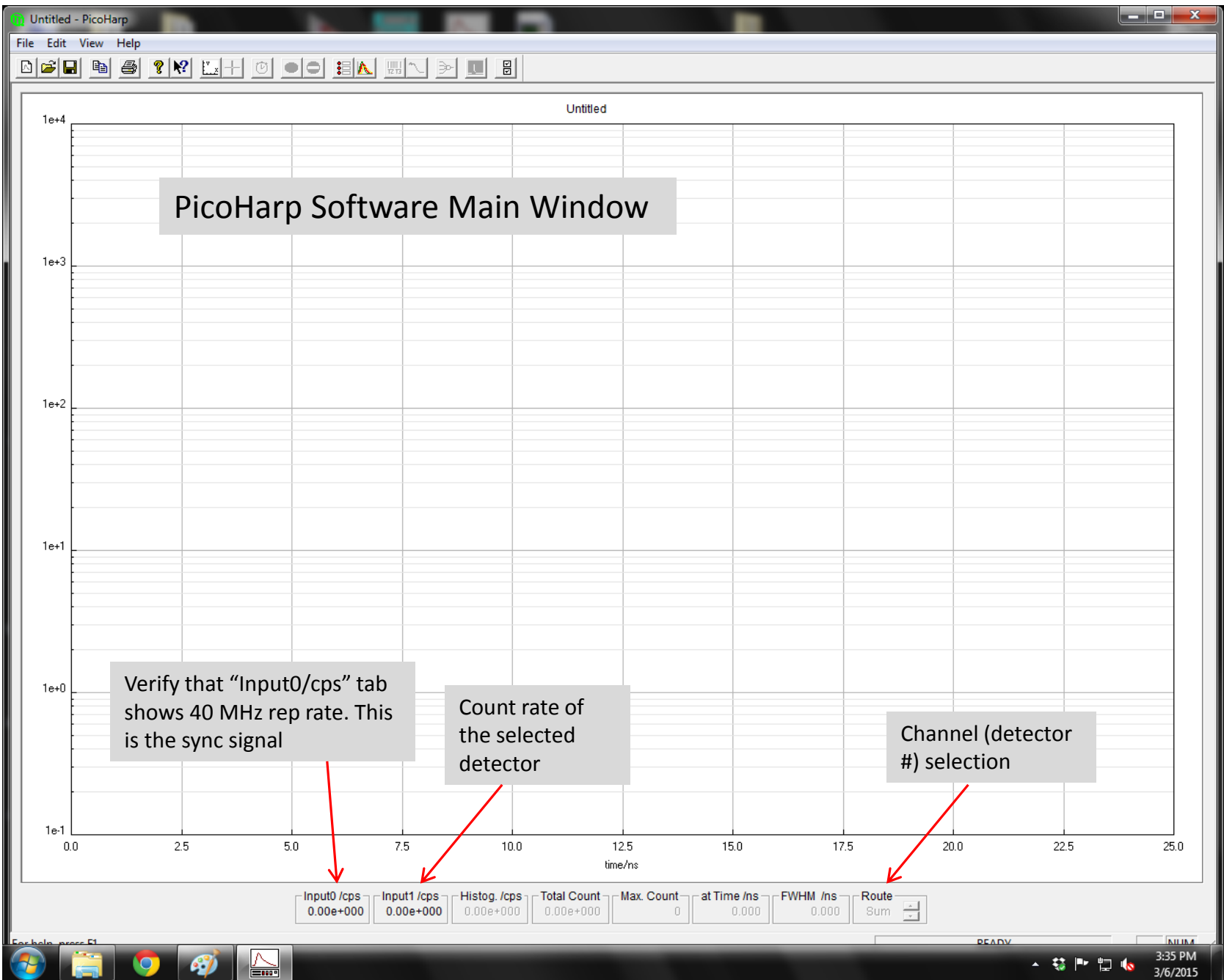

Hardware Settings in PicoHarp Software



Icon to Launch Control Panel Window

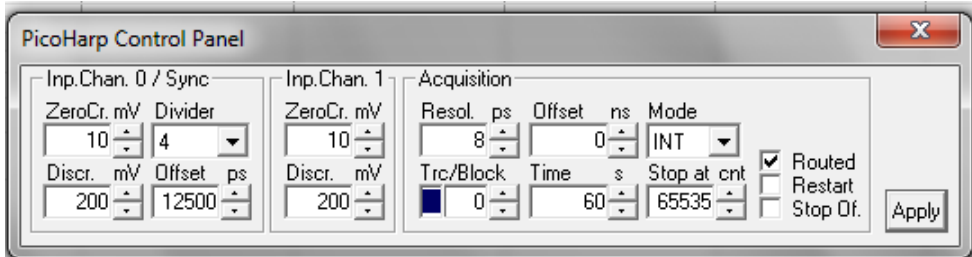

Default Settings for Control Panel

- Input Channel 0/ Sync & Input Chan. 1
 - Zero Cr: 10 mV
 - Discr.: 200 mV
 - Divider: 4
 - Offset: 12500 ps
- Acquisition
 - Routed box should be checked.



Icon to Launch Dialog Window for PHR 800 Router.

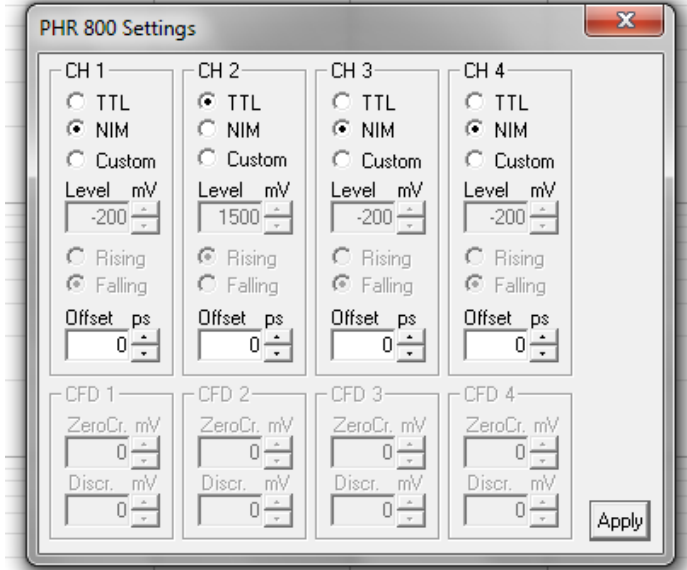

Make sure correct signal type is selected (NIM or TTL) depending on cable connection to APD. Current:

- Channel 1: TauSPAD = NIM
- Channel 2: EG&G = TTL



Icon to Launch Dialog TTTR Mode

T3 is usual selection

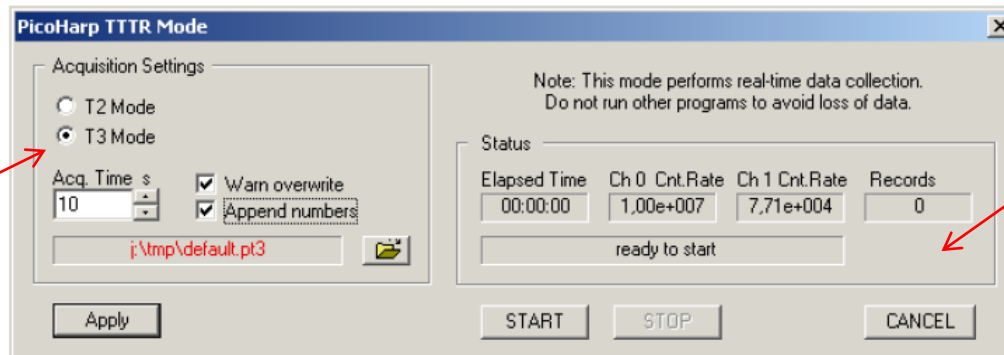

Be aware of any warning  appearing here before starting any measurement.

PicoQuant Router & Processor

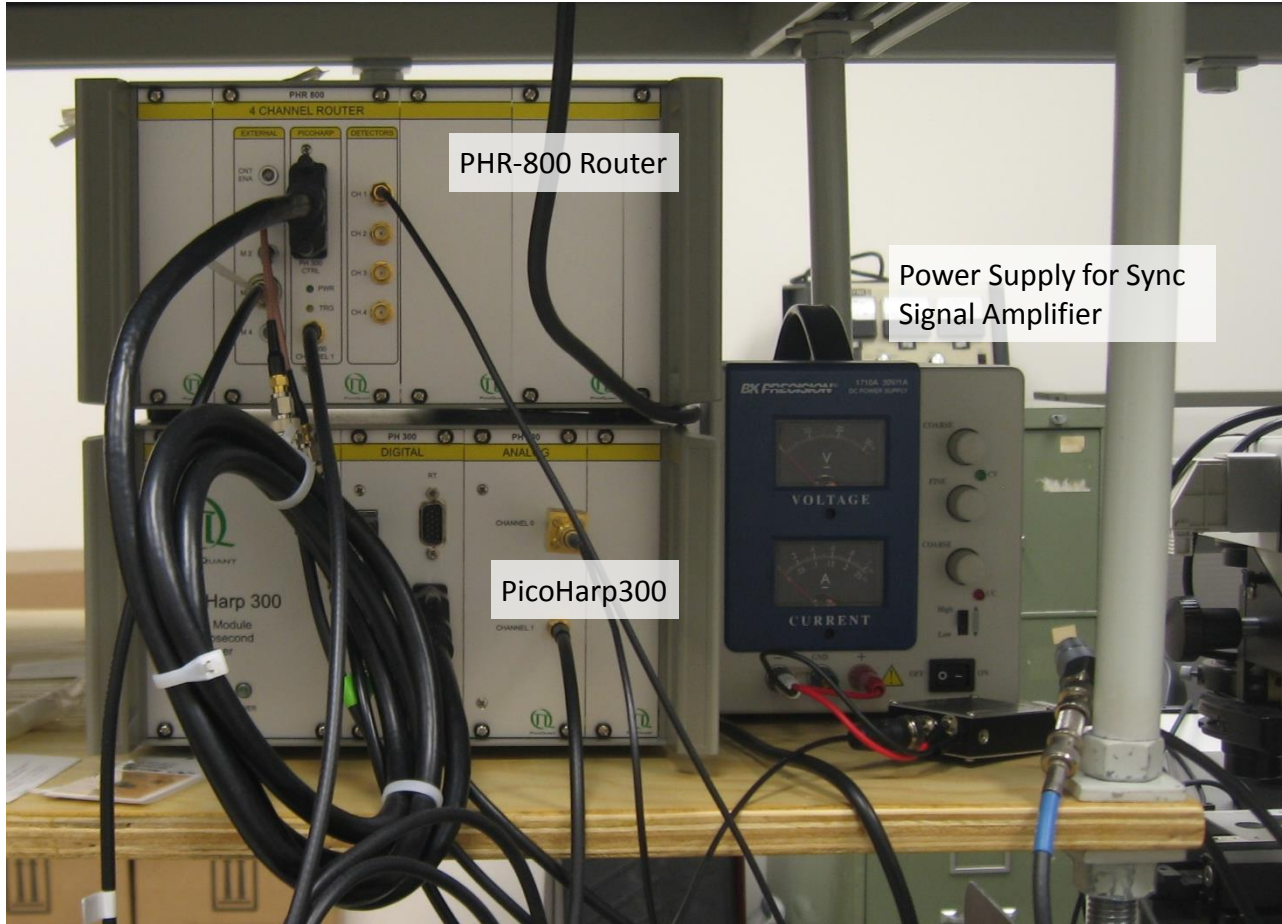

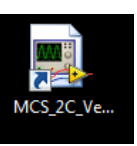

MCS Software: Record/Displays photon counts from APD detectors as function of time. Mostly used for detector alignment.

Click arrow to start program

Set the time bin (integration time), No. of bins and units. No. of bins does not apply to free run mode.

Start/Stop measurement

Toggle switch to select free run for alignment or Record to record and save data

Exit program

Mad City Labs Nano-Stage Controller



- Use toggle switch to power on/off
- Input signals (X, Y, Z) from National Instruments 9269 DAQ module.
 - X-Axis → Ch 0 (NI 9269)
 - Y-Axis → Ch 1
 - Z-Axis → Ch 2

