

***Nikon***

**Microscope**  
**ECLIPSE 80i**  
**Instructions**  
**<Microscopy>**

# Introduction

---

Thank you for purchasing this Nikon product.

This instruction manual, which describes basic microscope operations, is intended for users of the Nikon ECLIPSE 80i microscope.

To ensure correct use, please read this manual carefully before operating the product.



- This manual may not be reproduced or transmitted in whole or in part without Nikon's express consent.
- The contents of this manual are subject to change without notice.
- Although every effort has been made to ensure the accuracy of this manual, errors or inconsistencies may remain. If you note any points that are unclear or incorrect, please contact your nearest Nikon representative.
- Some of the products described in this manual may not be included in the set you have purchased.
- Make sure you have read the manuals for any other products attached to or to be used with this microscope (super high-pressure mercury lamp power supply, high-intensity light source, etc.).

## Warning/Caution symbols used in this manual

---

Although Nikon products are designed to provide the utmost safety, ignoring safety precautions or improper use may result in personal injury or property damage, as well as voiding the terms of the warranty. To ensure safe use, please read the instruction manual carefully and thoroughly before trying to operate the instrument. Do not discard this manual. Store in a convenient location near the product for ready reference.



In this manual, safety precautions are indicated by the following symbols. For safe, correct use of the microscope, always follow the instructions indicated by these symbols.

Symbol	Meaning
 <b>WARNING</b>	Disregarding instructions indicated by this symbol may result in death or serious injury.
 <b>CAUTION</b>	Disregarding instructions indicated by this symbol may result in injury or property damage.

## Meaning of symbols used on the product

---

When appearing on the product, the symbols below indicate the need for caution at all times during use. Consult the instruction manual and read the relevant instructions before attempting to use or adjust any part to which the symbol has been affixed.

	<p><b>Caution! Biohazard</b></p> <p>This symbol found on the stage indicates the following:0</p> <ul style="list-style-type: none"><li>• WARNING: Contact between sample and microscope may result in biohazard risks.</li><li>• To avoid biohazard contamination, avoid touching the contaminated portion with bare hands.</li><li>• Decontaminate the contaminated part according to the standard procedure specified for your laboratory.</li></ul>
	<p><b>Caution for heat</b></p> <p>This symbol found on the lamphouse of the ECLIPSE 80i indicates the following:</p> <ul style="list-style-type: none"><li>• The lamp and surrounding areas (including the lamphouse) become very hot during and immediately after a period of illumination.</li><li>• Risk of burns. Do not touch the lamp or surrounding areas during or immediately after a period of illumination.</li><li>• Make sure the lamp and surrounding areas have cooled sufficiently before attempting to replace the lamp</li></ul>

# Safety Precautions

---

Please follow the safety precautions given below.



## WARNING

### 1. Intended use of the product

This product is intended primarily for microscopic observations of cells and tissue set on glass slides using diascope (transmitted) and episcopic illumination.

It is intended for use in experimentation and observation of cells and tissue in the fields of pathology and cytology in hospital and other laboratory settings.

### 2. Do not disassemble.

Disassembly may result in malfunctions and/or electrical shock and will void the terms of the warranty. Never attempt to disassemble any part other than the parts described in this manual. If you experience problems with the product, contact your nearest Nikon representative.

### 3. Read the instruction manuals carefully.

To ensure safety, carefully read this manual and the manual provided with any other equipment used with this product. Observe all warnings and cautions given at the beginning of each manual.

#### **When the digital imaging head or the D-FL Epi-illumination attachment is attached to the microscope**

The mercury lamp (or xenon lamp) for Epi-fl microscopy requires special care during handling. Make sure you have read the instruction manual for the light source (super high-pressure mercury lamp power supply or high-intensity source).

### 4. Power cord for microscope and the power cord for AC adapter

Use one of the power cords specified. Using the wrong power cord may result in fire or other hazards. The product is classified as subject to Class I protection against electrical shock. Make sure it is connected to an appropriate ground terminal.

Refer to Chapter 8 for the power cords specified.

To prevent electric shock, always turn off the main power switch (press it to the "O" position) of the product before attaching or detaching the power cord.

### 5. Inspect the AC adapter (when using the D-CB C-BOX).

The D-CB C-BOX is powered by an AC adapter. Use only the specified adapter model meeting the requirements. Using any other type of adapter may result in malfunction, overheating, and/or fire. Refer to Chapter 8 for the adapter specified.

- To prevent malfunctions and/or fire, use the AC adapter in a well-ventilated location. To ensure proper heat radiation and to prevent overheating, never cover or place any object on the adapter.
- To prevent malfunctions, always turn off the power switch (the switch is in the out position) of the C-BOX before attaching the AC adapter.

**WARNING****6. Heat from the light source**

The lamp and surrounding areas (including the lamphouse) will become very hot during and immediately after a period of illumination.

- Risk of burns. Never touch the lamp or surrounding areas during or immediately after a period of illumination.
- Make sure the lamp and surrounding areas have cooled sufficiently before attempting to replace the lamp
- To avoid risk of fire, do not place fabric, paper or highly flammable volatile materials such as gasoline, petroleum benzene, paint thinner or alcohol near the lamphouse while the lamp is lit or during a period of around thirty minutes after the lamp has been turned off.

**7. Mercury lamps and xenon lamps (when the digital imaging head or the D-FL Epi-illumination attachment is attached)**

The mercury lamp (or xenon lamp) for the digital imaging head or the D-FL Epi-illumination attachment requires special care during handling. For safe and correct use of this system, carefully read the warnings below. Keep in mind all potential hazards. Additionally, carefully read the manual for the super high-pressure mercury lamp power supply (or high-intensity light source) and the manual (if provided) from the lamp manufacturer, then follow the instructions given therein.

**Hazards of Mercury Lamps and Xenon Lamps**

- 1) When lit, mercury (and xenon) lamps radiate ultraviolet light that can damage your eyes and skin. Direct viewing of the light may result in blindness.
- 2) The lamps contain sealed gas under very high pressure, pressure that increases when the lamp is on. If the lamp is scratched, fouled, subjected to high external pressure or physical impact, or used beyond its service life, the sealed gas may escape or the lamp may burst, resulting in gas inhalation, injury from glass, or other injury.
- 3) When the lamp is lit, the lamp and surroundings will become extremely hot. Touching the lamp with bare hands may result in burns; flammable materials placed near the lamp may ignite.
- 4) Using the wrong lamp type may result in accidents, including bursting of the lamp.

Safety is a top design priority for Nikon products. The preceding hazards should pose no danger as long as the user observes all of the warnings and cautions given in the manuals, and uses the system only for its intended purpose.

However, failure to heed the warnings and cautions given in the manuals, subjecting the system to shock or impact, or attempting to disassemble the system may result in accidents and injury. Make sure you are familiar with and adhere to all warnings and cautions.

**8. Always turn off the lamp when changing filter cubes (when the digital imaging head or the D-FL Epi-illumination attachment is attached to the microscope).**

When changing filter cubes, always turn off the digital imaging head or the D-FL Epi-illumination attachment. Leaving the lamp on may result in ultraviolet exposure.

**9. Leave the D/UV slider in the optical path (when using the digital imaging head or the D-FL Epi-illumination attachment).**

Always leave the D/UV slider (which is one of the D-ES EPI ND slider types) in the optical path when performing Epi-bright-field microscopy, Epi-dark-field microscopy, or Epi-DIC microscopy with the mercury lamphouse attached. If the slider is moved out of the path, ultraviolet light will be radiated and damage your eyes.



**WARNING**

**10. Hazardous Sample**

This microscope is intended primarily for microscopic observations of cells and tissue set on glass slides.

Check to determine whether a sample is hazardous before handling.

Handle hazardous samples according to the standard procedure specified by your laboratory.

If the sample is potentially infectious, wear rubber gloves and avoid touching samples. If contact occurs between a sample and the microscope, decontaminate the contaminated portion according to the standard procedure specified for your laboratory.



**CAUTION**

**1. Turn off power during assembly, connection/disconnection of cords, lamp replacement, and maintenance.**

To prevent electric shock and/or malfunctions, always turn off the power switch(es) of the product (press it (them) to the "!" position) and unplug the power cord from the wall outlet before assembly, connecting or disconnecting of cords, lamp replacement, and cleaning of the microscope and the objective.

**2. Lamp replacement precautions**

To avoid burns, wait at least 30 minutes after the lamp is turned off to give it sufficient time to cool.

To avoid electric shock or malfunctions, never attempt to replace the lamp without first turning off the power switches for the microscope and the peripheral devices (press them to the "!" position) and unplugging the power cord from the wall outlet.

Make sure the lamphouse cover is securely fitted to the lamphouse after lamp replacement. Never turn on the lamp while the lamphouse cover is open. Do not break up used lamps; instead, dispose of them as special industrial waste or as specified by local regulations.

**3. Use the specified lamp and lamphouse.**

Always use the specified lamp and lamphouse. Using an unspecified lamp may cause malfunction or fire. Refer to Chapter 8 for the specified lamp and lamphouse.

**4. Avoid contact with water.**

Never allow water to come into contact with the product, and keep the product away from liquids.

Splashing water onto the product may cause a short, resulting in malfunction or abnormal heating. If water is splashed onto the product, immediately turn off the power switch (press it to the "!" position) and remove the power cord from the receptacle. Then wipe off moisture with a dry cloth or something similar. If water enters the product, do not use; in this case, contact your distributor.

**5. Do not place any object on top of the product.**

Do not place any object on top of the product or cover it with a cloth or the like. The system temperature will rise, resulting in malfunctions.



**CAUTION**

**6. Cautions on assembling and installing the microscope**

- Take care to avoid pinching your fingers or hands during microscope assembly.
- Scratches or fouling such as fingerprints on optical components (such as lens and filters) will degrade microscope images. Be careful to avoid scratches or direct contact with the lens and filters.
- The main unit weighs about 12 kg. Grasp the main unit by the recesses at the front of the arm and at the bottom of the main unit.
- Remove all attachments (if attached) from the microscope before carrying the microscope.
- Do not install the product in a locker or cabinet.

**7. Remove any covers from the product before switching on.**

Do not use the product while covered with a cloth, etc., as this will give rise to abnormal heat, which could cause a fire.

**8. Caution concerning long, sustained observations**

To relieve fatigue resulting from long observation sessions, limit continuous observations to one hour. Take at least 10- to 15-minute breaks between observation sessions. Adjust the layout of other equipment (such as the display and the mouse) and match to the position of the product and the height of your chair.

**9. Disposal of the product**

To avoid biohazard risks, dispose of the product as contaminated equipment according to the standard procedure specified for your laboratory.

## Notes on handling the product

### 1. Handle the product gently.

This product is a precision optical instrument and requires gentle handling. Avoid subjecting it to sudden impact and shocks.

Even relatively minor impacts are capable of affecting the precision of the object.

### 2. Weak electromagnetic waves

The product emits weak electromagnetic waves. Do not place precision electronic devices near the product to avoid degrading their performance. If TV or radio reception is affected, move the TV or radio farther away from the product.

### 3. Scratches, dirt, and foreign particles on the lens

Scratches or fouling such as fingerprints on optical components (such as lens and filters) will degrade microscope images. If these parts become dirty, clean them as described in chapter "7. Care and maintenance" at the end of this manual.

### 4. Dirt on the lamps

Never touch the lamp with bare hands. Dirt or fingerprints on the lamp will result in uneven illumination and reduce the service life of the lamp. Always wear gloves when handling lamps.

### 5. Installation location

This product is a precision instrument. Use or storage in inappropriate environments may result in malfunctions or poor performance. Consider the following factors when selecting an installation location:

- Select a vibration-free location. Install the product on a level surface.
- Install the product at least 10 cm away from walls.
- Choose a location less exposed to hazards in the event of collisions, earthquakes, or other potential disasters. To keep the product from falling, use strong rope or other means if necessary to secure it to the working desk or to another heavy, stable item. To fix the microscope, there are two M6 screw holes (one at the right and the other at the left) behind the recess at the base of the main body (back side).
- Avoid locations exposed to direct sunlight, locations immediately under room lights, and other bright locations.
- Avoid locations with excessive dust.
- Do not install the product near any liquid.
- Make sure the ambient temperature is 0 to 40°C and humidity is 85% or less. Installing the 80i in hot, humid locations may result in mildew formation or condensation, impairing performance or generating malfunctions.
- Do not install the product in a locker or cabinet.
- Select a layout that allows easy removal of the power cord from the product's AC inlet in the event of an emergency.
- Room lights just above the microscope may reduce visibility in the objective as extraneous light. If possible, switch off room lights directly above the microscope when making observations.



## 6. Focusing knobs

- Never turn the focus knobs on the left and right sides of the microscope in opposite directions at the same time. Doing so may damage the microscope.
- Turning the coarse focus knob past its farthest point will damage the microscope. Never use undue force when turning the knob.

## 7. Protect the ports from dust and extraneous light (when the trinocular eyepiece tube, the digital imaging head, or the C-TE ergonomic binocular tube is attached).

To keep out extraneous light and dust, always attach the supplied cap to any port not currently in use.

## 8. Handling of filters (when the digital imaging head or the D-FL Epi-illumination attachment is attached to the microscope)

- Interference filters (especially excitation filters, which are exposed to strong light) degrade over time. Replace them after the appropriate hours.
- Filter characteristics may alter if the filter is exposed to high humidity. To prevent changes in or degradation of filter characteristics, avoid using or storing the filters under conditions of high humidity or high temperature. Avoid subjecting filters to rapid temperature changes. When a filter is not in use, store in a desiccator or hermetically sealed container with a drying agent.
- The filters in the nine types of filter cubes listed below offer sharp, high-resolution waveform characteristics superior to normal filters. However, due to their sophisticated coatings, they must be handled with special care. In particular, take care to avoid abrasion from cleaning. (Follow the procedure described in section "1. Filter and lens cleaning" of chapter "7. Cleaning and Maintenance.")  
Single-band filter cubes: DAPI, FITC, TxRed, GFP  
Multi-band filter cubes: F-R, F-T, D-F, D-F-R, D-F-T

## 9. Handling of the D-FLD dark-field illumination cube (when using the digital imaging head or the D-FL Epi-illumination attachment)

There are two wings in front of the D-FL Epi-illumination attachment, these prevent light leakage. Do not apply any pressure onto the wings, as malfunction may result.

## 10. Unpacking and unclamping

- 1) Check the contents to ensure that the package contains the following:
  - ECLIPSE 80i x1
  - Tools: Hex wrench x2  
Allen key x1
  - Accessories: Shield cover x1  
Dust-proof cover x1
- 2) Before connecting the power cord, remove the cushioning material from under the sub-stage by turning the focusing handle and raising the sub-stage.
- 3) Do not discard the packing case, as it may be needed for future transportation.

## Abbreviations Used in The Manual

The product names and abbreviations used in this manual are given below.

The manual uses the following abbreviations:

Name of device	Abbreviation
Microscope ECLIPSE 80i	80i
C-ER Eye Level Riser	Eye Level Riser
C-TE Ergonomic Binocular Tube	Ergonomic Binocular Tube
C-TEP DSC Port for Ergonomic Binocular Tube	DSC Port
D-FL Epi-illumination Attachment	Epi-illumination Attachment
D-DH Digital Imaging Head M	DIH-M
D-CB C-Box	C-Box
D-LH Precentered Lamphouse	Lamphouse
D-NID6 Intelligent Sextuple DIC Nosepiece	Intelligent Nosepiece
C-HS Hand Switch	Hand Switch
DS Camera Head DS-5M	Camera Head
DS Camera Control Unit DS-L1	DS-L1
DS Camera Cable	Camera Cable
Super High-pressure Mercury Lamp Power Supply Unit	Mercury Lamp Power Supply Unit
Super High-pressure Mercury Lamphouse	Mercury Lamphouse

## How to use this instruction manual

This instruction manual is composed of two parts, as below:



Manual 1 "Microscopy" describes basic microscope operations that you must follow. Please read this manual carefully before operating the product.

Manual 2 "Reference" describes the operations of each attachment. Please read an appropriate section as necessary.

	<b>Title</b>	<b>Importance</b>	<b>Content</b>
Manual 1	Microscopy	Must be read	Safety precautions Microscopy, Assembly, Troubleshooting, Cleaning and maintenance, Specifications
Manual 2	Reference	As necessary	Detailed operations of attachments

## Using Microscopy Manual

The part names and microscopy procedures are described in three separate sections, corresponding to specific configurations of 80i and accessory devices. Confirm the combination of the 80i and accessory devices you are using, then refer to the appropriate section.

Combination	Description
<p><b>Bright-field set</b></p> <p>(Eyepiece tube mounted directly on 80i)</p> <p>(Camera and monitor are optional.)</p> 	<p><b>See Chapter 1.</b></p> <p>(For operating procedures and detailed information on individual parts, refer to the separate Reference manual.)</p>
<p><b>80i + Epi-illumination attachment</b></p> <p>(Camera and monitor are optional.)</p> 	<p><b>See Chapter 2.</b></p> <p>(For operating procedures and detailed information on individual parts, refer to the Reference manual.)</p>
<p><b>80i + DIH-M</b></p> <p>(Camera and monitor are optional.)</p> 	<p><b>See Chapter 3.</b></p> <p>(For operating procedures and detailed information on individual parts, refer to the Reference manual.)</p>

## Contents

Introduction .....	1
Warning/Caution symbols used in this manual .....	2
Meaning of symbols used on the product .....	2
Safety Precautions .....	3
WARNING.....	3
CAUTION.....	5
Notes on handling the product .....	7
Abbreviations Used in The Manual .....	9
How to use this instruction manual .....	10
Using Microscopy Manual .....	11
Chapter 2 Part Names and Microscopy Procedures (With Epi-illumination Attachment Mounted) .....	24
2.1 Names of Main Components .....	24
2.2 Names of Parts Used to Make Adjustments.....	25
2.2.1 Right view .....	25
2.2.2 Left view .....	26
2.2.3 Rear view (without accessory device) .....	26
2.3 Bright-Field Microscopy .....	27
2.4 Epi-fluorescence Microscopy .....	31
2.5 Photomicroscopy .....	35
Chapter 4 Assembly .....	51
Chapter 5 Replacing Consumables .....	63
5.1 Replacing the lamp.....	63
.....Chapter 6 Troubleshooting.....	64
6.1 Optical.....	64
6.2 Electrical.....	65
Chapter 7 Cleaning and Maintenance .....	66
7.1 Lens cleaning .....	66
7.2 Cleaning the product .....	66
7.3 Disinfecting the product .....	66
7.4 Storage.....	67
7.5 Periodic Inspections (fee charged).....	67
Chapter 8 Specifications.....	68
8.1 Specifications .....	68

# 2

## Part Names and Microscopy Procedures (With Epi-illumination Attachment Mounted)

### 2.1

### Names of Main Components

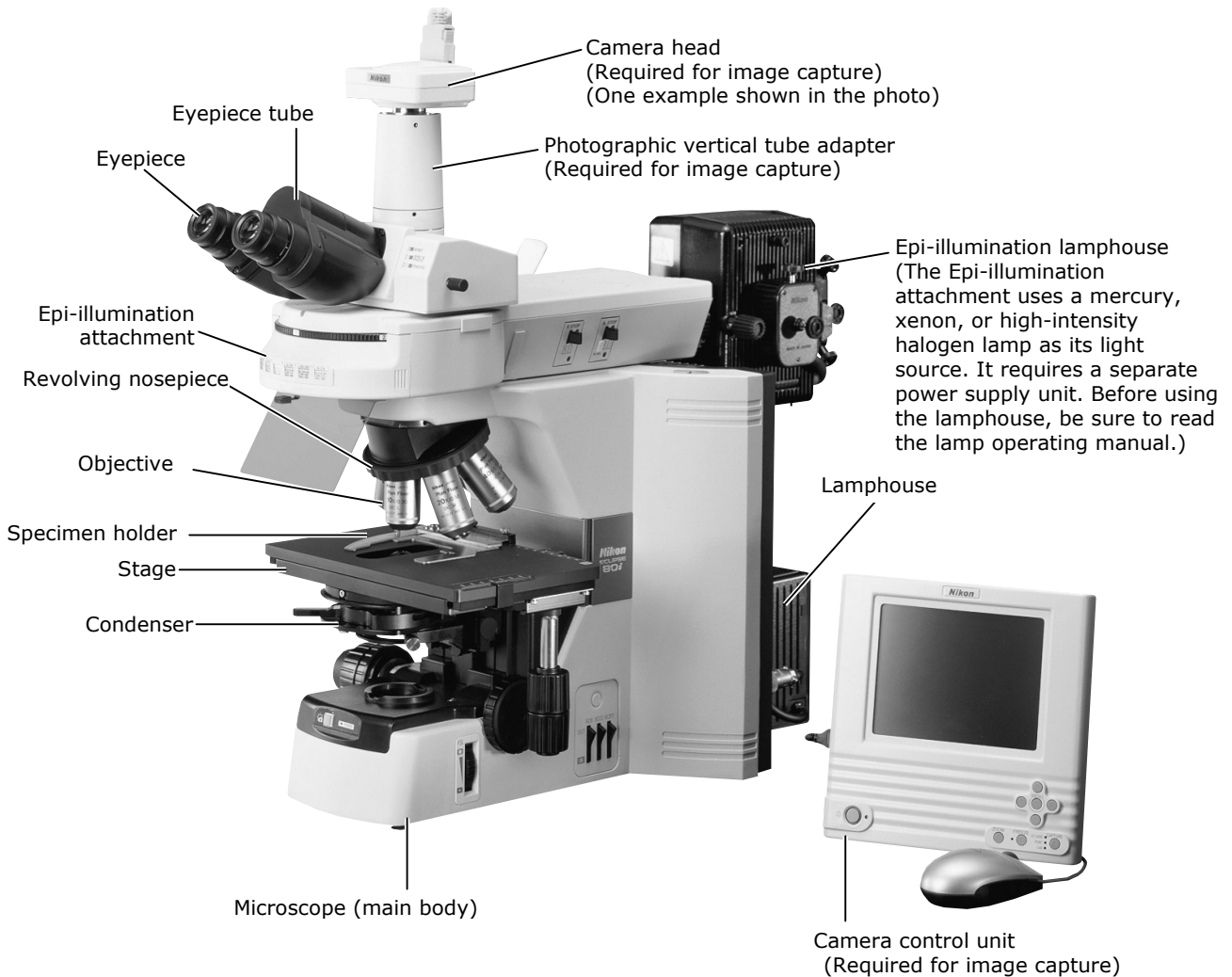

2.2 Names of Parts Used to Make Adjustments

**2.2 Names of Parts Used to Make Adjustments**

**2.2.1 Right view**

2

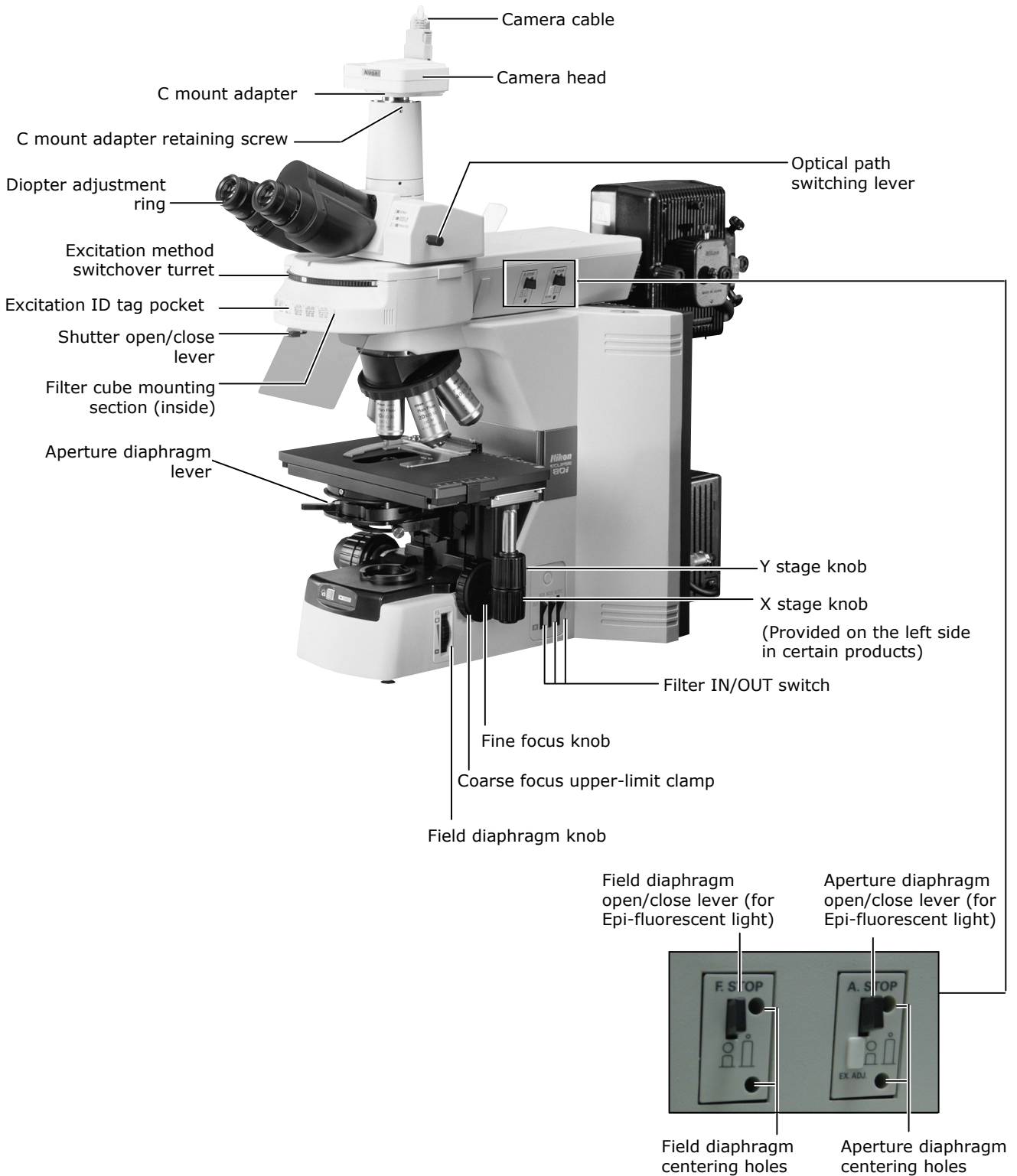

2.2 Names of Parts Used to Make Adjustments

**2.2.2 Left view**

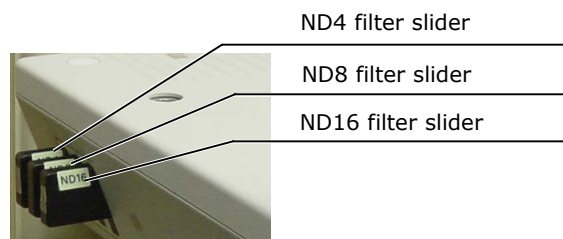
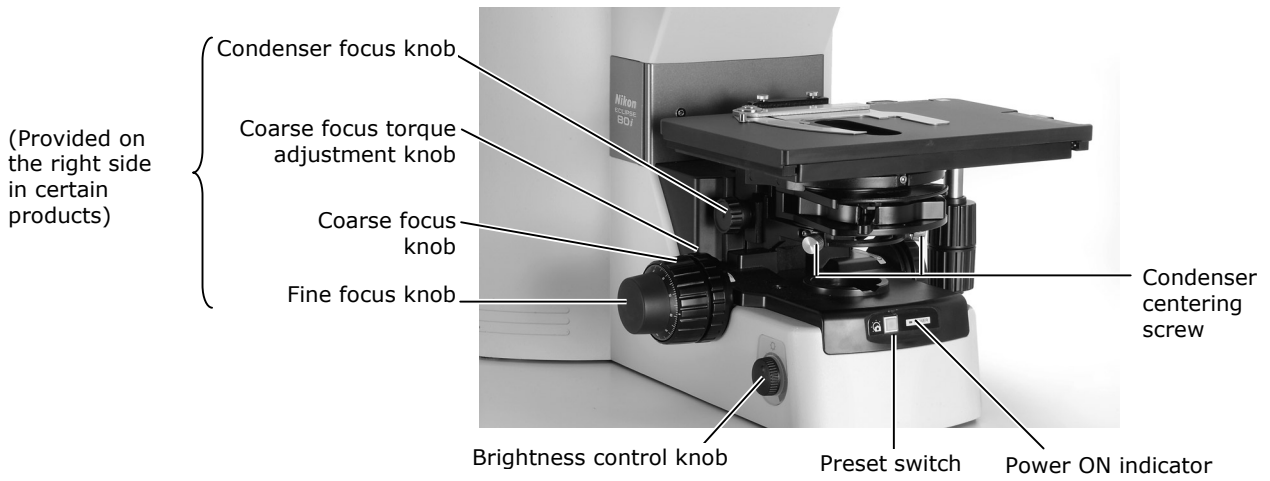

Left side the Epi-illumination attachment

**2.2.3 Rear view (without accessory device)**

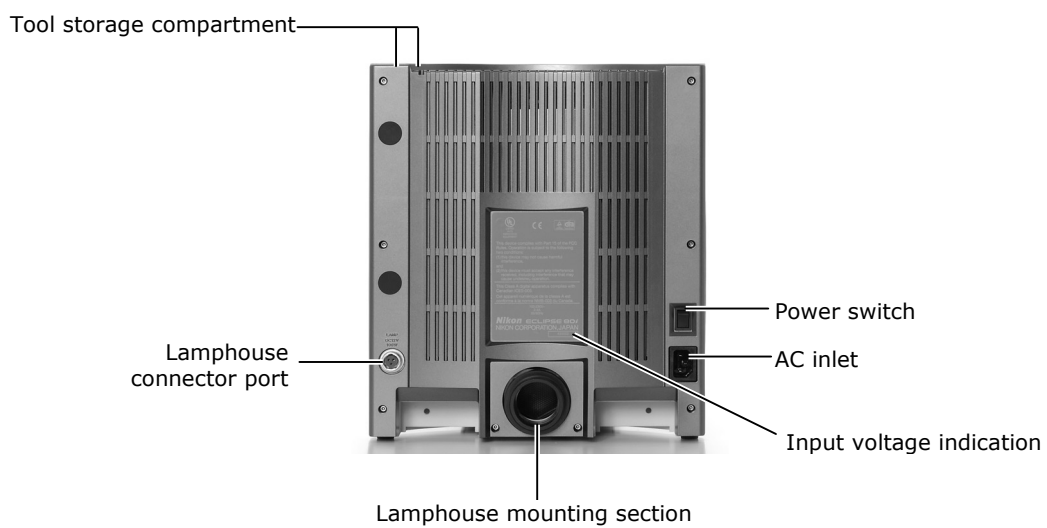



## 2.3 Bright-Field Microscopy

**1** Turn on power.



Press the power switch to the "I" position.

**2** Press the preset switch.



Press the preset switch.

**3** Move the ND8, ND32, and NCB11 filters into the optical path.



NCB11  
ND32  
ND8

**4** Push the optical path-switching lever to direct the full optical path toward the binocular section.

The full optical path directed toward binocular section

Push in the optical path-switching lever.



2.3 Bright-Field Microscopy

- 5 Rotate the excitation method switchover turret to set it at position where no filter cube is installed.**



Rotate the excitation method switchover turret.

- 6 Raise the condenser to the uppermost position.**

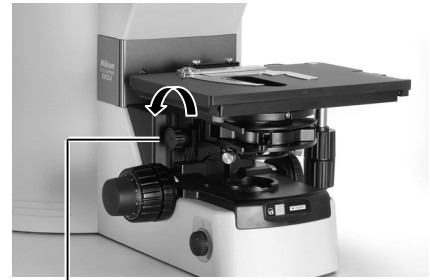

Raise the condenser using the condenser focus knob.

- 7 Fully open the field diaphragm and aperture diaphragm.**

(When using the 1-100x condenser, move the top lens into the optical path.)

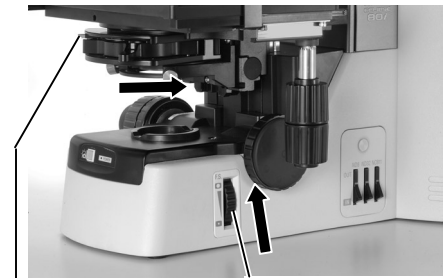

Fully open the aperture diaphragm using the aperture diaphragm lever.

Fully open the field diaphragm using the field diaphragm knob.

- 8 Set the 10x objective into the optical path.**



Select the 10x objective.

2.3 Bright-Field Microscopy

**9 Set a specimen and move the portion to be viewed into the optical path.**

Set a specimen and secure in place using the specimen holder.



Move the portion to be viewed into the optical path using the XY stage knobs.

**10 Focus on the specimen.**



Focus on the specimen using the coarse and fine focus knobs.

**11 Adjust the diopter and the interpupillary distance.**

Refer to "8. Diopter Adjustment" and "9. Interpupillary Distance Adjustment" in the separate Reference manual.



**12 Focus and center the condenser.**

Refer to "11. Adjustment of Condenser Position" in the separate Reference manual.



Focus the condenser using the condenser focus knob.

Center the condenser using the condenser centering screws.

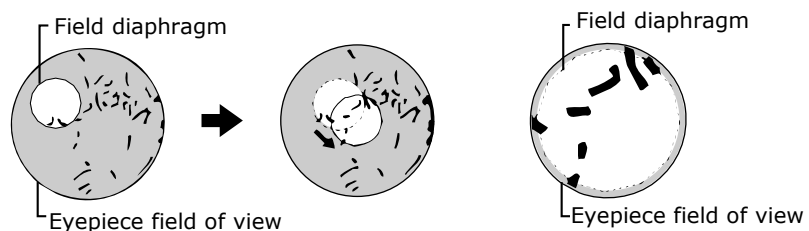

2.3 Bright-Field Microscopy

**13** Switch to the desired objective and view the specimen. Adjust the field diaphragm and aperture diaphragm each time you change objectives.



Select the desired objective.

Field diaphragm:

Set slightly narrower than the margins of the field of view.

Aperture diaphragm:

70% to 80% of the maximum numerical aperture (N.A.) of the objective



Aperture diaphragm      Field diaphragm knob

**14** Turn off power after completing observations.



Press the power switch to the "O" position.

## 2.4 Epi-fluorescence Microscopy

### Before microscopy...

- Check the cumulative operating hours of the lamp in the Epi-illumination attachment. Replace the lamp if its cumulative operating hours exceed the recommended maximum service life.
- Use non-fluorescent slide glass.
- Use non-fluorescent immersion oil.
- To keep specimen colors from fading, keep the shutter closed when not performing microscopy.

**1** Perform steps 1 through 11 in "2.3 Bright-Field Microscopy."

**2** Lower the condenser, or remove the condenser and mount the shielding tube in its place.

**3** Turn off the microscope power switch.

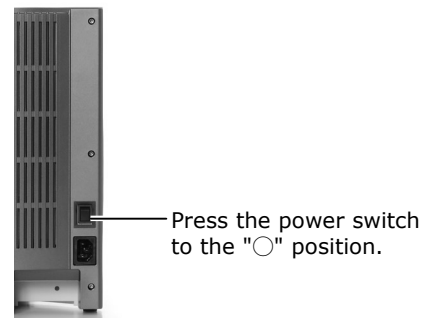

**4** Close the shutter and block the Epi-illumination light.



**5** Move the filter cube for the excitation method to be used into the optical path.

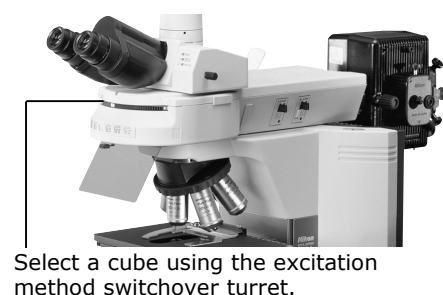

2.4 Epi-fluorescence Microscopy

- 6 Fully open the field diaphragm and aperture diaphragm of the Epi-illumination attachment.**



Fully open the field diaphragm.

Fully open the aperture diaphragm.

- 7 Switch on power for the light source of the Epi-illumination attachment, then open the shutter and center the lamp. (Refer to the operating manual for the light source.)**



Open the shutter.

- 8 Set the 10x objective into the optical path.**



Select the 10x objective.

- 9 Set a specimen and move the portion to be viewed into the optical path.**

Set a specimen and secure in place using the specimen holder.



Move the portion to be viewed into the optical path using the XY stage knobs.

2.4 Epi-fluorescence Microscopy

# 10 Focus on the specimen.

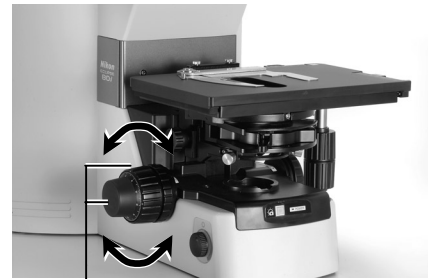

Focus on the specimen using the coarse and fine focus knobs.

# 11 Center the field diaphragm of the Epi-illumination attachment.

Refer to "4. Epi-fluorescent Field Diaphragm" in "17. Fluorescence Observation" of the separate Reference manual.

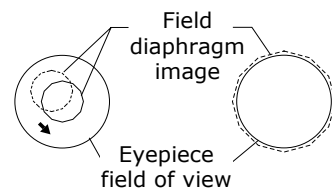
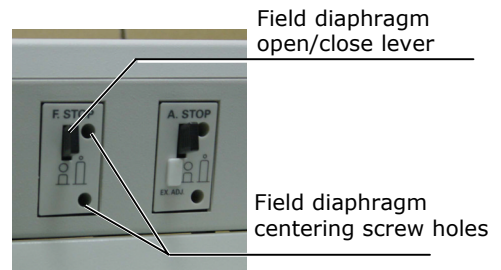

# 12 Switch to the desired objective and view the specimen.

- Use the ND filters for the fluorescence attachment to adjust brightness.
- Adjust the field diaphragm so that it extends slightly beyond the field of view.
- The image brightness can be adjusted with the aperture diaphragm. Complete centering before using the aperture diaphragm.
- When using oil immersion objectives, apply immersion oil between the specimen and the objective.



Select the desired objective.

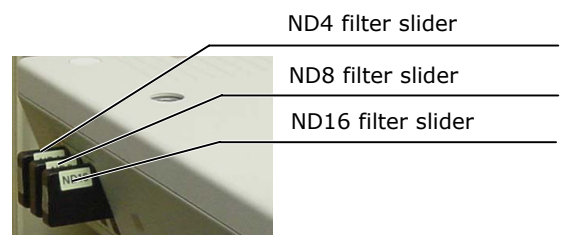

2.4 Epi-fluorescence Microscopy

# 13 To return to bright-field microscopy

- Close the shutter of the Epi-illumination attachment and block the epifluorescent light.
- Rotate the excitation method switchover turret to move the position where no fluorescent cube is installed into the optical path.
- If the condenser is not mounted, install the condenser, then focus and center the condenser. (Refer to step 12 of bright-field microscopy.)
- Turn on the microscope power switch to turn on the diascopic light source.

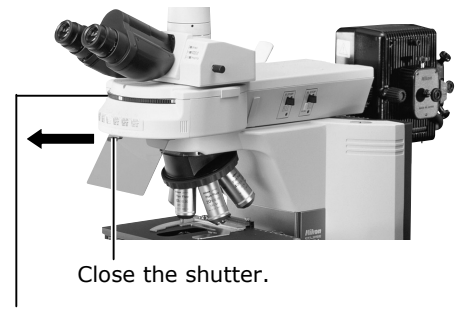

Use the excitation method switchover turret to change cubes.



Press the switch to the "I" position.

# 14 Turn off all power switches after completing observations.



Press the power switch to the "O" position.



## 2.5 Photomicroscopy

For detailed discussions of the camera, photomicroscopic software, and PC, refer to the operating manuals provided with the respective products. The following instructions assume a DS-5M digital camera and DS-L1 camera control unit.

### 1 Adjust the microscope for proper image observation.

See the directions given in previous "1. Bright-Field Microscopy" or "2. Epi-fluorescence Microscopy."

### 2 Adjust the camera head mounting position until the image is displayed properly.

- (1) Adjustment based on stage motion direction  
Loosen the C-mount adapter retaining screw and adjust the camera position so that moving the stage forward-backward or left-right moves the image on the monitor in the same direction. After making the appropriate adjustments, tighten the screw firmly.

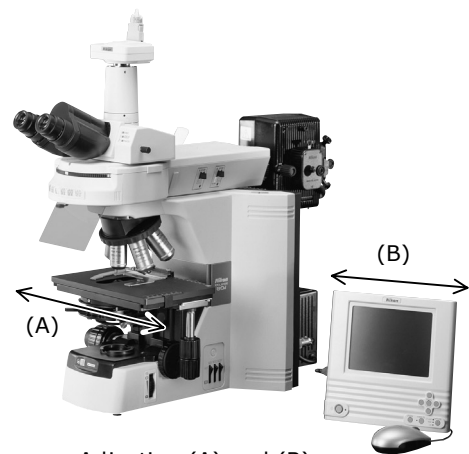

Adjusting (A) and (B)

C-mount  
adapter  
retaining  
screw



### **3 Make camera settings.**

For a detailed discussion of this topic, refer to the operating manual provided with the camera. When using the DS-L1, you must choose and enter at least the following information:

- Folder for data storage.
- Name of file to be saved. (You can select "Auto.")
- File format and file size.
- Date and destination of data

### **4 Select the camera scene mode suitable for the microscopy method.**

### **5 Set the camera white balance.**

To adjust white balance, press the WB button while capturing an image of a clear section of a specimen slide. (For fluorescent photomicrography, adjust white balance under normal lighting conditions before shooting.)

### **6 Capture and save images.**

Focus on the specimen.

Refocus.

Adjust image brightness using the camera exposure compensation function.

Check the image using the Freeze button.

If the image is acceptable, press the CAPT. button to save the image.

(The operating procedure differs if DF/FL scene mode is selected. For a detailed discussion of this topic, refer to the operating manual provided with the camera.)

## 1 Checking the Input Voltage

Check the input voltage indicated on the back of the microscope. Use the microscope only if this indication matches the power supply voltage for the area in which the microscope will be used.

Note: If the voltage indication and supply voltage differ, do not attempt to use the microscope. Contact your nearest Nikon representative to seek advice.

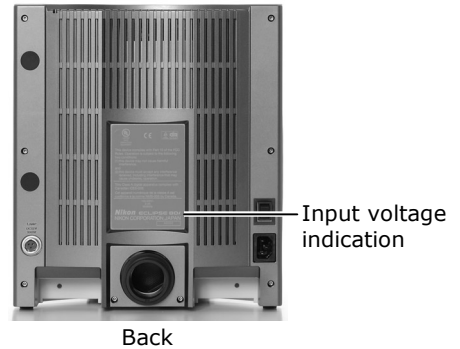

## 2 Installing a Lamp

- (1) Loosen the lamphouse-cover fixing screw and lift the lamphouse cover to remove.
- (2) Attach the lamp to the lamp plug. Avoid touching the bare lamp bulb with your bare hands. Use the lamp type specified. Using an unspecified lamp may cause malfunction or fire. Refer to Chapter 8 for the specified lamp.
- (3) Replace the cover and tighten the screw.

Lamphouse-cover fixing screw

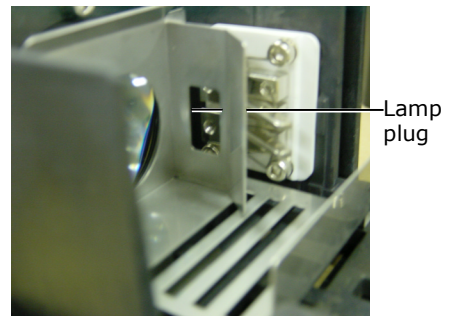

### CAUTION

**The lamphouse cover must be attached. Failure to replace the lamphouse cover may result in burns or fire from the heat generated by the lamp.**

### 3 Attaching the lamphouse

- (1) Attach the lamphouse to the back of the microscope and fix it with the fixing screw.
- (2) Attach the connector.

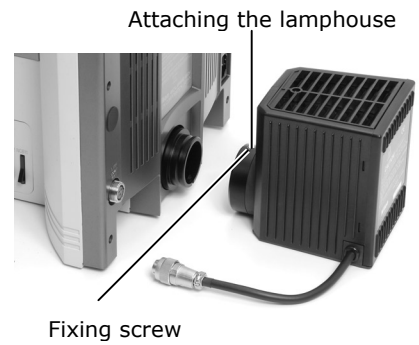

### 4 Installing a Stage

- (1) Turn the coarse focus knob to remove the cushioning material from the elevating section.



- (2) Place the stage on the elevating section and fix into place with two screws.  
(For the stage with a centering function, place the stage on the elevating section by aligning the projection on the back of the stage with the groove of the elevating section.)



Fixing the stage

Screws fixing the stage



Groove

Stage with centering function

Projection



Back of the stage with centering function

- (3) Place a specimen holder on the stage and secure with screws.



Fixing the stage with centering function



Fixing the specimen holder

## 5 Installing a Condenser

- (1) Turn the coarse focus handle until the elevating section is raised to the highest position.
- (2) Turn the condenser focus knob until the elevating section is brought to the lowermost position.
- (3) Insert a condenser and adjust so that it faces toward the front. Secure in place with a tool stored in the back of the microscope.
- (4) Turn the condenser focus knob until the elevating section is raised to the uppermost position.

Condenser focus knob

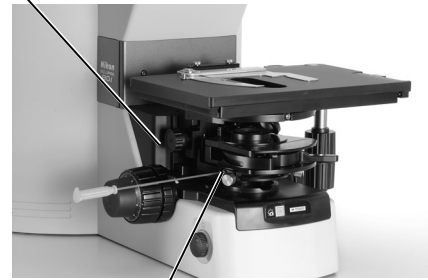

Fixing condenser

## 6 Installing an Eyepiece Tube directly

- (1) Place an eyepiece tube on the microscope arm.
- (2) Attach the eyepiece by aligning the projection of the eyepiece tube sleeve with the notch at the objective.
- (3) Attach a screw hole protection sticker provided with the system to the bolt hole found on the top surface of the arm.



Fixing the eyepiece tube

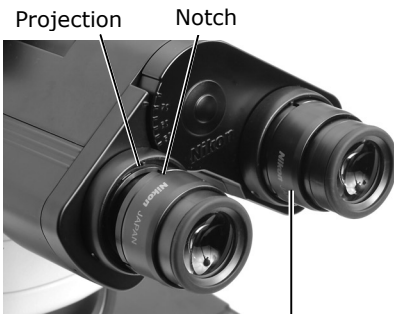

Eyepiece attached in place

## 7 Installing an Epi-illumination attachment

- (1) Place an Epi-illumination attachment on the microscope arm and fix it with a screw at the front of the arm.
  - (2) Secure in place with two screws at the back of the Epi-illumination attachment.
  - (3) Attach a screw hole protection sticker provided with the system to the bolt hole.
  - (4) Attach a mercury lamphouse to the bayonet mount on the back. (For more information, refer to the instruction manual provided with the super high-pressure mercury lamp power supply.)
    - 1) Attach a collector lens to the lamphouse.
    - 2) Turn the bayonet mount clockwise (viewed from the back) as far as it will go.
    - 3) Insert the lamphouse into position.
    - 4) Turn the bayonet mount anticlockwise (viewed from the back) to lock the lamphouse.
  - 5) Attach a mercury lamp.
  - 6) Connect the mercury lamphouse to the mercury lamp power supply.
- (5) Attach the eyepiece tube.
- (6) Attach the eyepiece by aligning the projection of the eyepiece tube sleeve with the notch at the objective.

Screws to fix the Epi-illumination attachment (three screws in total)



Bayonet mount

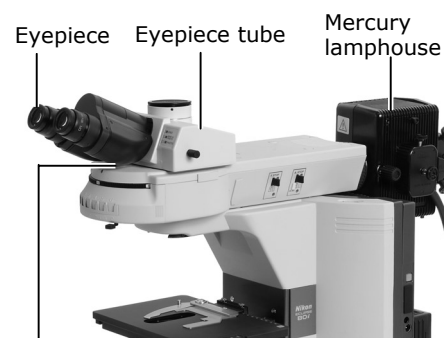

Eyepiece tube fixing screw

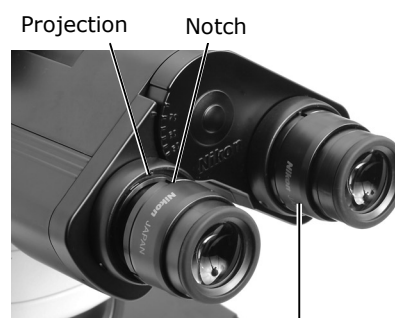

Eyepiece attached in place

## 8 Using the DIH-M

- (1) Attach two C-BOXs to the back of the microscope with screws.



- (2) Place the DIH-M on the microscope arm and fix it with a screw at the front of the arm.

- (3) Remove the back cover of the DIH-M by loosening the two screws.

- (4) Fix the DIH-M to the microscope with two screws inside the arm.

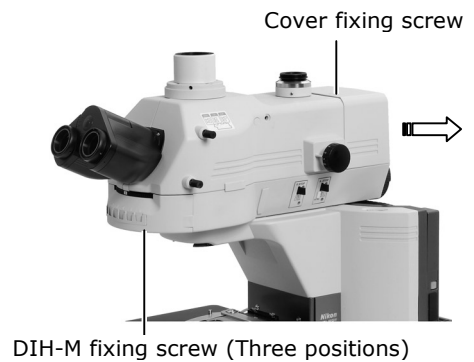

- (5) Connect the ferrite core side of the control cable to the CTL connector. When inspecting DIH-M conditions, also attach the USB cable. In this case, the other end of the USB cable is connected to the PC. (The control cable and the USB cable are provided with the DHI-M.)

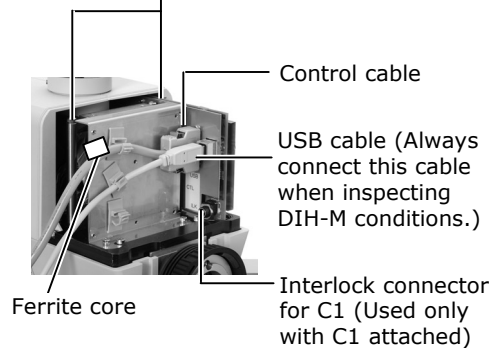

- (6) Replace the cover.

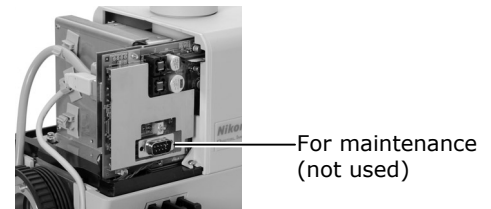

Viewed from the other side



- (7)** Connect the control cable attached to the DIH-M to the C-BOX.
- 1) Remove the cover on the left side of the DIH-M.
  - 2) Loosen the optical path switching section fixing board mount screw.
  - 3) Loosen the two optical path switching section fixing screws and remove the clamp from the inside of the optical path switching section. (This frees the optical path switching lever.)
  - 4) Move the fixing board slightly forward with the fixing screws attached, then tighten the mount screw.
  - 5) Replace the cover.
  - 6) Loosen the zooming section fixing screw to remove the clamp from the DIH-M.
  - 7) Attach the blind cap provided.

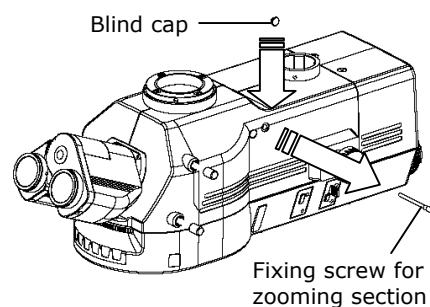
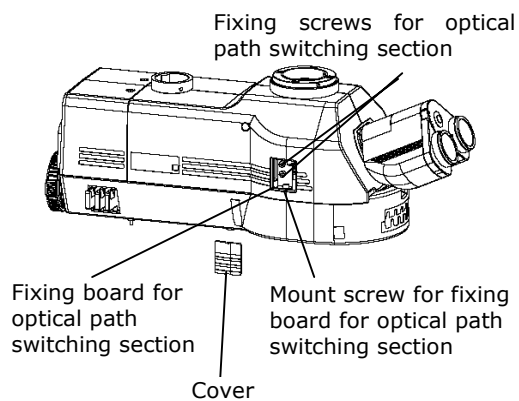

- (8)** Connect the control cable attached to the DIH-M to the C-BOX.



- (9)** Attach the hand switch for the Epi-illumination shutter to the C-BOX.



Attach the hand switch for the Epi-illumination shutter here.

**(10)** Attach the mercury lamphouse to the back of the bayonet mount. (For more information, refer to the instruction manual provided with the super high-pressure mercury lamp power supply.)

- 1) Attach a collector lens to the lamphouse.
- 2) Turn the bayonet mount clockwise (viewed from the back) as far as it will go.
- 3) Insert the lamphouse into position.
- 4) Turn the bayonet mount anticlockwise (viewed from the back) to lock the lamphouse.
- 5) Attach a mercury lamp.
- 6) Connect the mercury lamphouse to the mercury lamp power supply.



**(11)** Attach the eyepiece by aligning the projection of the eyepiece tube sleeve with the notch at the objective.

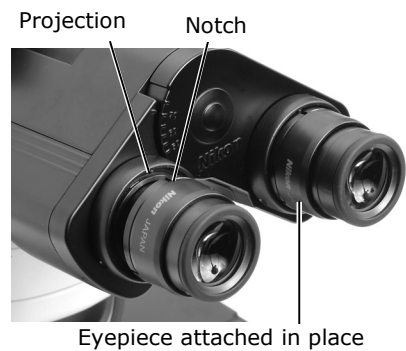

## 9 Installing a Revolving Nosepiece

- (1) Lift the revolving nosepiece from a position just forward of the point directly below the fitting part and slide toward the back to attach. (Continue sliding the revolving nosepiece until its front position is aligned with that of the fitting part.)
- (2) Secure with the screw.

Fixing the revolving nosepiece

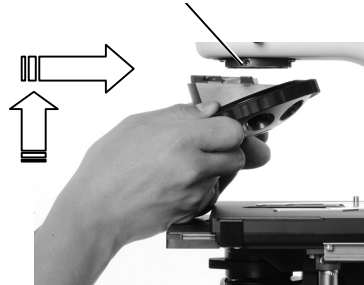

- (3) When using the intelligent revolving nosepiece, connect the connector attached to the revolving nosepiece to the upper port found inside the C-BOX.

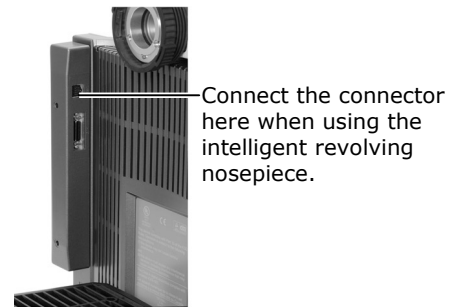

## 10 Installing Objectives

Screw objectives into the revolving nosepiece. When installing the objective in this way, make sure that the magnification of the objective increases when the revolving nosepiece is turned clockwise (clockwise when viewed from above the eyepiece).

# 11 Installing Filter Cubes and a Light Shield (when the Epi-illumination attachment or the DIH-M is installed)

- (1) There is a front cover below the eyepiece. Pull out the cover to remove.
- (2) Insert a filter cube into position.



Filter cube

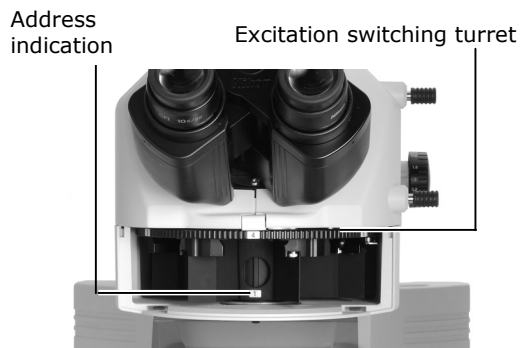

Filter cube fitting part

- (3) Insert a nameplate into the position with the same address as the one indicated on the filter cube select knob on the right side of the microscope.
- (4) Turn the filter cube select knob and insert a filter cube into the remaining open position.
- (5) Replace the cover.

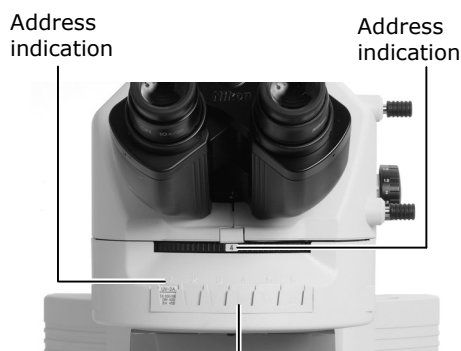

Nameplate

- (6) Attach a light shield to the front bottom of the fluorescent unit with screws.



Light shield attached (with DIH-M)



Light shield attached (with Epi-illumination attachment)

# 12 Installing a Camera (when using a camera)

## 12-1 When attaching to the ergonomic binocular tube:

- (1) To attach a camera head, screw it into the C mount on the DSC port.
- (2) Remove the rear cover of the ergonomic binocular tube and insert the DSC port.
- (3) Secure the DSC port into place with screws.

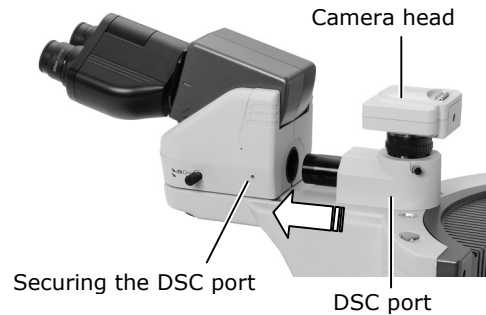

- (4) Attach the camera cable to the camera head. (Adjust the fitted position before using the camera. Refer to 2.4 operation procedure.)

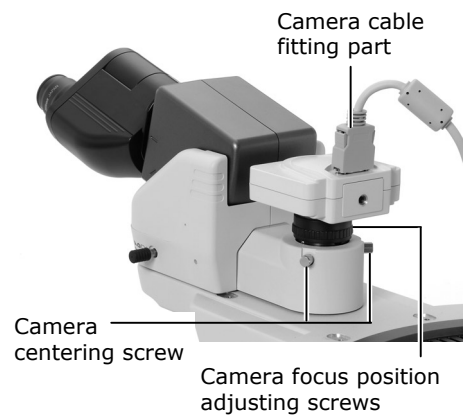

## 12-2 When attaching to the trinocular eyepiece tube:

- (1) Attach the camera head to the trinocular eyepiece tube using the C-mount adapter.
- (2) Attach the camera cable to the camera head. (Adjust the fitted position before using the camera.)



## 12-3 When attaching the DIH-M:

- (1) Attach the camera head to the DIH-M using the C-mount adapter that is near the rear port.
- (2) Attach the camera cable to the camera head. (Adjust the fitting position before using the camera.)

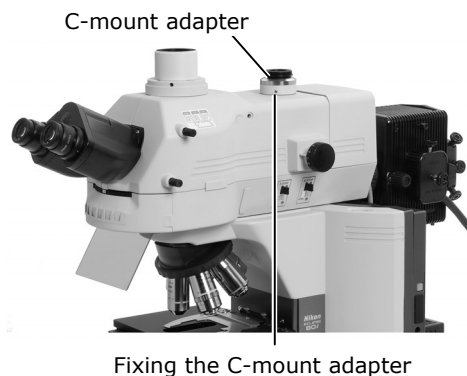

## 13 Installing the Power Cord

- (1) Check to confirm that the microscope power switch is off.
- (2) Insert one end of the power cord into the AC inlet at the back of the microscope.
- (3) Insert the other end of the power cord into the wall outlet.

Use only the specified power cord.  
Refer to Chapter 8 for the power cord specified.

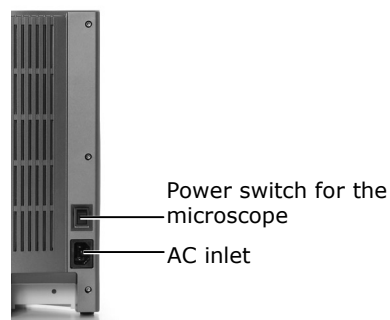

Right side of the back

## 14 Connecting the AC Adapter (when using the DIH-M)

- (1) Confirm that the power switch of the C-BOX (attached to the back of the microscope) is off (the button projects out).

- (2) Connect the AC adapter to the bottom port on the front of the C-BOX.

- (3) Connect the AC adapter to the wall outlet with the power cord.

Use only the AC adapter and power cord specified.  
Refer to Chapter 8 for the specified AC adapter and power cord.

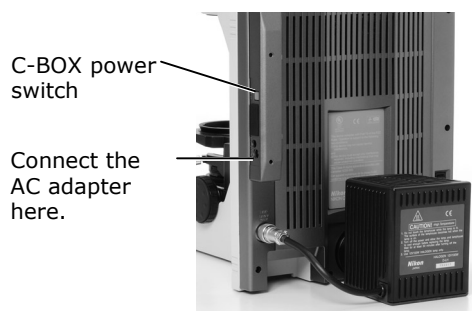

**Microscope assembly is now complete.**

**CAUTION**

- **Be careful to avoid burns:**  
Wait until the lamp and nearby parts have cooled before attempting to replace the lamp.
- **Be careful to avoid electrical shock:**  
Turn off the power switch and unplug the power cord from the outlet.
- **Be careful to avoid abnormal heat generation:**  
Use only the lamp specified.
- **Be careful to avoid actions that might reduce lamp service life:**  
Avoid touching the bare lamp bulb with bare hands. Soiling will reduce the service life of the lamp.

- (1) Loosen the screw and lift the cover to remove.
- (2) Remove the old lamp.
- (3) Replace with a new lamp.  
Avoid touching the bare lamp bulb with bare hands.  
Use only the lamp specified. Refer to chapter 8 for the specified lamp.
- (4) Replace the cover and fix it with the screw.

Lamphouse cover fixing screw

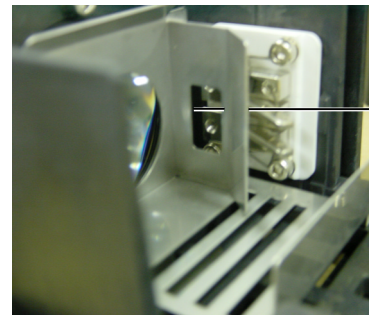

Lamp plug

**CAUTION**

**The lamphouse cover must be attached. Failure to replace the lamphouse cover may result in burns or fire from the heat generated by the lamp.**

# 6

## Troubleshooting

If the microscope does not function properly, take appropriate action as described below. If the problem is still not resolved after referring to "Troubleshooting," please contact your nearest Nikon representative

### 6.1

### Optical

Problem	Possible causes	Remedy
View field vignetting Uneven illumination across the view field View field not visible	Parts installed incorrectly	Install the Parts (nosepiece, condenser, field diaphragm unit, aperture diaphragm unit, etc.) correctly.
	Movable parts not switched correctly	Switch the parts (optical path switching lever, excitation method switching turret, nosepiece, filter slider, condenser turret, etc.) correctly. (Operate the parts to a position until you feel resistance.)
	Condenser adjusted in correctly	Adjust the condenser so that the field diaphragm image is shown in the center of the viewing field.
	Improper objective-condenser combination	Use a proper combination.
	Lamp installed incorrectly	Install the lamp securely and adjust it as necessary.
	Field diaphragm not sufficiently opened	Open the field diaphragm to the proper setting.
Dirt or dust in the field of view	Dirt and dust on lens, condenser, eyepiece lens, filter and specimen	Clean.
	Field diaphragm image not focused on the specimen surface	Focus and center the condenser.
	Field diaphragm closed too far	Open the field diaphragm to the proper setting.
Poor image quality Poor contrast Poor resolution	Field diaphragm closed or opened too far	Open or close the field diaphragm to the proper setting
	Objective correction ring not adjusted	Adjust the correction ring to match the cover glass.
	Condenser maladjusted	Adjust the condenser so that the field diaphragm image is shown in the center of the viewing field.
	Cover glass unattached Cover glass thickness not as specified	Attach a cover glass of the specified thickness (0.17 mm).
	Tip pf the oil-immersed objective not immersed in oil	Use Nikon immersion oil.
	Unspecified immersion oil used	
	Air bubbles in immersion oil	Remove the air bubbles.
	Immersion oil attached to tip of the dry objective	Clean.
Uneven focus	Dirt or dust on lens, condenser, eye piece lens, filter and specimen	Clean.
	Revolving nosepiece not installed correctly, or not rotated to the click stop position	Install correctly and rotate to the click stop position.
	Specimen projecting from the stage surface	Securely attach the specimen to the stage specimen holder.



## 6.2 Electrical

Problem	Possible causes	Remedy
Image flows	Revolving nosepiece not installed correctly, or not rotated to the click stop position	Install correctly and rotate to the click stop position.
	Specimen projecting from the stage surface	Securely attach the specimen to the stage specimen holder.
	Condenser tilted	Install correctly and rotate to the click stop position.
Yellow-tinged	NCB11 filter not being used	Use the NCB11 filter.
View field too bright	Lamp voltage too low	Press the Preset switch and adjust the brightness to match the ND filter combination.
	Lamp voltage too high	
View field too dark	Lamp voltage too low	Open the aperture diaphragm to the proper setting.
	Condenser aperture diaphragm stopped down too far	
	Condenser maladjusted	Adjust the condenser so that the field diaphragm image is shown in the center of the viewing field.
	Image light spread over too great an area	Adjust the light path switching lever to provide the target location with 100% light.
Focus impossible on a high-magnification objective	Specimen upside down	Attach the specimen to the stage with the cover glass face up.
	Unspecified cover glass thickness	Attach a cover glass of the specified thickness (0.17 mm).
	Diopter not adjusted	Adjust the diopter.
Too great a difference in focus after objective switching.	Diopter not adjusted	Adjust the diopter.
Specimen not moving smoothly	Specimen holder insufficiently attached to stage	Attach the specimen holder securely to the stage.
Images on the left and right eyepiece not coincident	Interpupillary distance incorrect	Make adjustment
	Diopter not adjusted	Adjust the diopter.

## 6.2

## Electrical

Problem	Possible causes	Remedy
No power despite power switch turned on	Power cord not connected or connected improperly	Connect properly.
Lamp does not light	Lamp burned out	Replace with specified lamp.
	Impossible to install the lamp	Replace with specified lamp.
Lamp burns out quickly	Lamp used is unspecified/incompatible	Replace with specified lamp.
Microscope brightness control knob not functional	Preset switch off	If off, switch it on.

# 7

## Cleaning and Maintenance

### 7.1

#### Lens cleaning

Keep the lens free of dust, fingerprints, etc. Dirt on the lenses or filters will affect image quality. If any of the lenses become dirty, clean them by the procedure given below.

- Brush away dust with a soft brush or wipe away gently with gauze.
- If fingerprints or grease gets on a lens, moisten a piece of soft, clean cotton cloth, lens tissue, or gauze with absolute alcohol (ethyl or methyl alcohol) and wipe.
- Use petroleum benzene only to remove immersion oil from the objective. For optimum results, we recommend following up petroleum benzene with absolute alcohol (ethyl or methyl alcohol). If petroleum benzene is unavailable, use methyl alcohol alone. When using just methyl alcohol, note that surfaces will need to be wiped repeatedly to ensure complete removal of immersion oil. Usually, three or four times should be sufficient to clean the lens.
- Never use petroleum benzene to clean the entrance lens at the bottom of the eyepiece tube or prism surface of the eyepiece tube.
- Absolute alcohol and petroleum benzene are highly flammable. Be careful when handling these materials, particularly around open flames or when turning the power switch on or off.
- Follow the instructions provided by the manufacturer when using absolute alcohol.

### 7.2

#### Cleaning the product

- We recommend using a silicon cloth to clean the microscope.
- For stubborn dirt, dampen a piece of gauze with neutral detergent and wipe gently.
- Use of organic solvents on plastic parts may result in discoloration.

### 7.3

#### Disinfecting the product

- For routine disinfection of the microscope, we recommend using 70% medical alcohol.
- If contact occurs between a sample and the microscope, determine whether the sample is hazardous. If the sample is hazardous, follow the standard procedures for your laboratory.
- Use of organic solvents on plastic parts may result in discoloration.

7.4 Storage

**7.4**

**Storage**

- Store the microscope in a dry location where mold is unlikely to form.
- Store the objectives and eyepieces in a dry box or similar container with a drying agent.
- Place the vinyl cover over the microscope to protect it from dust.
- Switch off the microscope (press the switch to the "O" position) and wait for the lamphouse to cool before covering the microscope with the vinyl cover.

**7.5**

**Periodic inspections (fee charged)**

To maintain the peak performance of the microscope, we recommend periodic inspections. Contact your nearest Nikon representative for more information. (Parts and service charges apply for this service.)

## Nikon Microscope ECLIPSE 80i

Model	ECLIPSE 80i
Main unit	
Optical system	CFI60 system (infinity-corrected CF optical system)
Main unit	T-shaped, double-winged
Illumination system	Flyeye illumination, power supply incorporated, with preset feature 12V/100W long-life halogen lamp (specified lamp housing: D-CH precentered lamp housing) (specified lamp: PHILIPS7724I or OSRAM HLX64623)
Focusing section	NCB11, ND8, ND32 incorporated (replaceable) Manual single-axis coarse/fine motion handle system (right coarse/fine motion, left coarse motion, calibration markings for fine motion: 1 $\mu$ m/markings) Stroke: 27 mm, with refocusing mechanism Coarse motion handle: 14mm/revolution, fine motion handle: 0.1 mm/revolution
Tube section	Binocular tube, ergonomic binocular tube (binocular section 100%, binocular: DSC port = 50:50) DSC port mountable to ergonomic binocular tube Trinocular eyepiece tube FUW (binocular: straight = 100:0, 0:100) Trinocular eyepiece tube TUW (binocular: straight = 100:0, 20:80, 0:100)
Nosepiece section	Sextuple nosepiece, sextuple DIC nosepiece, intelligent septuple nosepiece, intelligent septuple DIC nosepiece
Stage section	Vertical stage (vertical stage R: main centering unit)
Condenser section	Abbe condenser, achromat condenser, darkfield condenser (dry, oil) Phase contrast condenser (cannot be attached to main centering unit), achromatic aplanat condenser, LWD condenser 1-100X condenser, DIC condenser (oil), universal condenser (dry)
Eyepiece lens section	10x, field number: 22, 25
Input ratings	100-240V AC, $\pm$ 10%, 50/60Hz, 2.4A max.
AC adapter for C-BOX	Manufacturer: ILAN ELECTRONICS LTD. Model: F1650K Rated input voltage: 100V-240V AC, 1.2A max., 50-60Hz Rated input voltage: 12V DC, 3.5A max Other: UL-listed, GS-approved, CE-certified

## 8.1 Specifications

Power cord	<ul style="list-style-type: none"> <li>• 100-120V regions UL-listed detachable power cord set (3 conductor grounding Type SVT, AWG 18, 3m long maximum, rated at 125V AC minimum)</li> <li>• 230V areas EU/EN-approved 3-conductor power cord set (3 conductor grounding Type H05VV-F, AWG 18, 3m long maximum, rated at 250V AC minimum)</li> </ul>
Operating conditions	<p>Temperature: 0 to 40°C</p> <p>Humidity: 85% RH max. (no condensation)</p> <p>Altitude: 2000 m max.</p> <p>Degree of pollution: Degree 2</p> <p>Installation: Category II</p> <p>Electric shock protection class: Class I</p> <p>Indoor use only</p>
Transport/storage conditions	<p>Temperature: -20 to 60°C</p> <p>Humidity: 90% RH max. (no condensation)</p>
External dimensions and weight (main unit)	<p>External dimensions: 300 (W) x 338 (H) x 384 (D) mm</p> <p>Weight: Approx. 12 kg</p>
<p>Safety standards</p> <p>When using with the following attachments:</p> <ul style="list-style-type: none"> <li>• D-LH precentered lamphouse</li> <li>• D-DH digital imaging head M</li> <li>• D-CB C-BOX</li> <li>• D-NID6 sextuple DIC nosepiece</li> <li>• C-HS hand switch</li> <li>• Specified adapter for C-Box</li> </ul>	<ul style="list-style-type: none"> <li>• UL-Listed Product (UL61010A-1)</li> <li>• Meets FCC 15B Class A requirements.</li> </ul> <p>This equipment has been tested and found to comply with the limits for a Class A digital device, pursuant to Part 15 of the FCC Rules.</p> <p>These limits are designed to provide reasonable protection against harmful interference when the equipment is operated in a commercial environment.</p> <p>This equipment generates, uses, and can radiate radio frequency energy and, if not installed and used in accordance with the instruction manual, may cause harmful interference to radio communications.</p> <p>Operation of this equipment in a residential area is likely to cause harmful interference in which case the user will be required to correct the interference at his own expense.</p> <ul style="list-style-type: none"> <li>• This class A digital apparatus complies with Canadian ICES-003. Cet appareil numérique de classe A est conforme à la norme NMB-003 du Canada (NMB-003).</li> <li>• This group1 class B digital apparatus complies with Australian EMC (AS/NZS2064).</li> </ul> <p>CE Marking</p> <ul style="list-style-type: none"> <li>• Meets EU IVDD (In vitro diagnostic medical device Directive) requirements. (GM-approved: In vitro diagnostic medical device)</li> <li>• EMC Meets EU EMC Directive (EN61326) requirements.</li> </ul> <div style="text-align: right;">  </div>

## 8.1 Specifications

**D-DH Digital Imaging Head M for Nikon Microscopes**

Model	D-DH Digital Imaging Head M
Optical system	Infinity-corrected CF optical system Eyepiece lens field number: $\phi 25\text{mm}$ Variable intermediate magnification: Binocular tube 1X Front port 1x Rear port 0.8 to 2x (zoom ratio: 2.5, manual, with intelligent feature)
Light path switching	Manual 3-way (eyepiece section: 100%, front port 100%, rear port 100%) (with intelligent feature)
Eyepiece tube top viewing angle	25°
Fluorescent turret	Manual sextuple turret (with noise terminator, intelligent feature)
Aperture stop	Manual (unit detachable)
Field stop	Manual (unit detachable)
ND filter	Manual, 3 filters (slider type filters ND4, ND8, ND16)
Shutter	Motorized (controlled with external hand switch)
Analyzer slot	Yes (side surface)
Polarizer slot	Yes (side surface)
Compatible lamp housing	Hg, Xe, centered halogen (incompatible with precentered type)
External connection	USB C1 interlock D-CB C-BOX COM (for maintenance purposes)
Operating conditions	Temperature: 0 to 40°C Humidity: 85% RH max. (no condensation) Altitude: 2000 m max. Degree of pollution: Degree 2 Installation: Category II Indoor use only
Transport/storage conditions	Temperature: -20 to 60°C Humidity: 90% RH max. (no condensation)
External dimensions and weight	External dimensions: 172 (W) x 185 (H) x 521 (D) mm (excluding projections) Weight: Approx. 8 kg